



IMM.M.M.

Collari / Collars

B



B.M.M.



IMMHy^{press}

IMM Group

Dati generali

General data

Prodotte a norme DIN 3015, le staffe di fissaggio vengono fornite in diversi materiali

Manufactured to DIN 3015, the collars clamps are manufactured in:

- Polipropilene copolimero - con semi-collari sagomati (su richiesta anche con interno liscio). - Per le serie standard, pesante e doppia.
Polypropylene with ribbed clamp halve (on request smooth) - For standard, heavy-duty and double series.
- Poliammide autoestinguente - (Nylon 6-6 caricato al 20% con fibra di vetro, autoestinguente VO) - Per le serie standard, pesante e doppia.
Polyamide - (Nylon 6-6 loaded with 20% of fi breglass, self-extinguishing VO) - For standard, heavy-duty and double series.
- Gomma - Per le serie standard, pesante e doppia.
Rubber - For standard, heavy-duty and double series.
- Alluminio - Per le serie standard e pesante.
Aluminium - for standard and heavy-duty series.

Gli altri componenti delle staffe vengono prodotti di serie in

The other metallic components of the clamps are manufactured in:

- Acciaio FE 35 - piastre superiori, inferiori e binari di fissaggio.
Steel FE 35 - lower and upper plates; mounting rails.
- Acciaio A6S - viti e rondelle.
Acciaio A6S - viti e rondelle.

A richiesta, tutte le parti metalliche possono essere fornite in Acciaio Inox 304 - Inox 316 - Inox 316L.

On request we can produce all metallic parts in stainless steel 304 - 316 and 316L.

Come Ordinare

How to Order

CS P 1 - 0064
SCS P 1 - 0064

P	Polipropilene copolimero / Polypropylene	<i>(versione standard)</i>
M	Poliammide autoestinguente / Polyamide	<i>(su richiesta)</i>
R	Gomma / Rubber	<i>(su richiesta)</i>
A	Alluminio / Aluminium	<i>(su richiesta)</i>

● ● ● ● ● ● **Collari / Clamps**

Pagina / Page	2	3	4-6
standard clamps	 <p>CSPX Collari serie standard in Polipropilene</p>	 <p>CPPX Collari serie standard con piastra superiore in Polipropilene</p>	 <p>- Componenti per collari serie standard</p>
Pagina / Page	7		8-10
double clamps	 <p>CDPX Collari doppi in Polipropilene</p>		 <p>- Componenti per collari doppi</p>
Pagina / Page	11-12		13-16
heavy clamps	 <p>CHPX Collari serie pesante in Polipropilene</p>		 <p>- Componenti per collari serie pesante</p>

Dimensions and general characteristics may be changed at any time without prior notice.

Data contained herein are for information purpose only, and it does not enlarge, amend or imply any warranty other than provided by us with the product
Any use of the product not in conformance with our instructions may be dangerous.

CSPX Collari serie standard in Polipropilene

Standard clamps in Polypropilene

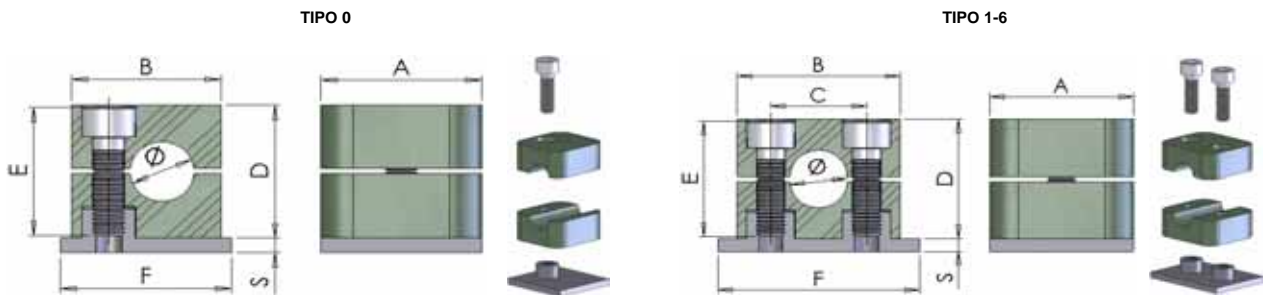

Codice Part number	Ø Tubo Ø Tube		Tipo Type	Dimensioni Dimension							
	Poll./Inch			A	B	C	D	F	S	E	
	mm	Gas		O.D.	mm						
CSP0-0060	6,0	1/8"	5/16"	0	30	28	-	27	32	3	M 6x20
CSP0-0080	8,0										
CSP0-0100	10,0										
CSP0-0120	12,0										
CSP1-0060	6,0	1/8"	1/4"	1	30	34	20	27	42	3	M 6x20
CSP1-0064	6,4										
CSP1-0080	8,0										
CSP1-0095	9,5										
CSP1-0100	10,0										
CSP1-0120	12,0										
CSP2-0127	12,7	3/8"	1/2"	2	30	40	26	33	48	3	M 6x25
CSP2-0135	13,5										
CSP2-0140	14,0										
CSP2-0150	15,0										
CSP2-0160	16,0		5/8"								
CSP2-0172	17,2										
CSP2-0180	18,0										
CSP2-0190	19,0										
CSP3-0190	19,0	1/2"	3/4"	3	30	48	33	35	55	3	M 6x30
CSP3-0200	20,0										
CSP3-0213	21,3										
CSP3-0220	22,0										
CSP3-0250	25,0										
CSP3-0254	25,4	3/4"	1"	4	30	57	40	42	62	3	M 6x35
CSP4-0269	26,9										
CSP4-0280	28,0										
CSP4-0300	30,0										
CSP4-0320	32,0	1"	1.1/4"	5	30	68	52	58	74	3	M 6x50
CSP5-0320	32,0										
CSP5-0337	33,7										
CSP5-0350	35,0										
CSP5-0380	38,0										
CSP5-0400	40,0										
CSP5-0420	42,0										
CSP5-0424	42,4										
CSP5-0450	45,0	1.1/2"	2"	6	30	86	66	66	88	3	M 6x60
CSP6-0445	44,5										
CSP6-0483	48,3										
CSP6-0508	50,8										

CPPX Collari serie standard con piastra superiore in Polipropilene

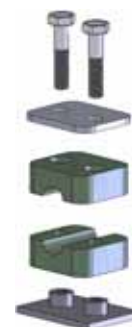
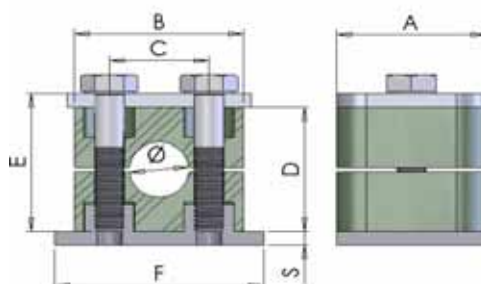

Standard clamps with upper plate in Polypropilene



Codice Part number	Ø Tubo Ø Tube			Tipo Type	Dimensioni Dimension						
	Poll./Inch		X		A	B	C	D	F	S	E
	mm	Gas			O.D.	mm					
CPP1-0060	6,0			1	30	34	20	27	42	3	M 6x30
CPP1-0064	6,4		1/4"								
CPP1-0080	8,0		5/16"								
CPP1-0095	9,5		3/8"								
CPP1-0100	10,0	1/8"									
CPP1-0120	12,0										
CPP2-0127	12,7		1/2"	2	30	40	26	33	48	3	M 6x35
CPP2-0135	13,5	1/4"									
CPP2-0140	14,0										
CPP2-0150	15,0		5/8"								
CPP2-0160	16,0	3/8"									
CPP2-0172	17,2										
CPP2-0180	18,0			3	30	48	33	35	55	3	M 6x40
CPP2-0190	19,0		3/4"								
CPP3-0190	19,0	1/2"									
CPP3-0200	20,0										
CPP3-0213	21,3		7/8"								
CPP3-0220	22,0										
CPP3-0250	25,0		1"	4	30	57	40	42	62	3	M 6x45
CPP4-0269	26,9	3/4"									
CPP4-0280	28,0										
CPP4-0300	30,0										
CPP4-0320	32,0		1.1/4"	5	30	68	52	58	74	3	M 6x60
CPP5-0520	32,0	1"									
CPP5-0337	33,7										
CPP5-0350	35,0		1.1/2"								
CPP5-0380	38,0										
CPP5-0400	40,0										
CPP5-0420	42,0	1.1/4"		6	30	86	66	66	88	3	M 6x70
CPP5-0424	42,4										
CPP5-0450	45,0										
CPP6-0445	44,5	1.1/4"									
CPP6-0483	48,3	1.1/2"									
CPP6-0508	50,8		2"								

Componenti per collari serie standard

Standard clamps components

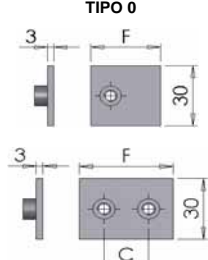
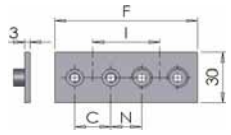
										
semi-collare in polipropilene		coppia collari in polipropilene		piastra inferiore		piastra inferiore doppia				
polypropilene clamp-half		polypropilene clamp body		lower plate		double lower plate				
code	price	code	price	F mm	(LPS...) C mm	F mm	C mm	N mm	I mm	n° collari clamps
TIPO 0		SCSP0-0060	CCSP0-0060	LPS0		LPDS0				
SCSP0-0080		CCSP0-0080		32	-	61	-	-	30	2
SCSP0-0100		CCSP0-0100								
SCSP0-0120		CCSP0-0120								
TIPO 1		SCSP1-0060	CCSP1-0060	LPS1		LPDS1				
SCSP1-0064		CCSP1-0064		42	20	81	20	20	40	2
SCSP1-0080		CCSP1-0080								
SCSP1-0095		CCSP1-0095								
SCSP1-0100		CCSP1-0100								
SCSP1-0120		CCSP1-0120								
TIPO 2		SCSP2-0127	CCSP2-0127	LPS2		LPDS2				
SCSP2-0135		CCSP2-0135		48	26	91	26	18	44	2
SCSP2-0140		CCSP2-0140								
SCSP2-0150		CCSP2-0150								
SCSP2-0160		CCSP2-0160								
SCSP2-0172		CCSP2-0172								
SCSP2-0180		CCSP2-0180								
SCSP2-0190		CCSP2-0190								
TIPO 3		SCSP3-0190	CCSP3-0190	LPS3		LPDS3				
SCSP3-0200		CCSP3-0200		55	33	106	33	19	52	2
SCSP3-0213		CCSP3-0213								
SCSP3-0220		CCSP3-0220								
SCSP3-0250		CCSP3-0250								
SCSP3-0254		CCSP3-0254								
TIPO 4		SCSP4-0269	CCSP4-0269	LPS4		LPDS4				
SCSP4-0280		CCSP4-0280		62	40	148	52	23	75	2
SCSP4-0300		CCSP4-0300								
SCSP4-0320		CCSP4-0320								
TIPO 5		SCSP5-0320	CCSP5-0320	LPS5		LPDS5				
SCSP5-0337		CCSP5-0337		74	52	148	52	23	75	2
SCSP5-0350		CCSP5-0350								
SCSP5-0380		CCSP5-0380								
SCSP5-0400		CCSP5-0400								
SCSP5-0420		CCSP5-0420								
SCSP5-0424		CCSP5-0424								
SCSP5-0450		CCSP5-0450								
TIPO 6		SCSP6-0445	CCSP6-0445	LPS6		LPDS6				
SCSP6-0483		CCSP6-0483		88	66	177	66	24	90	2
SCSP6-0508		CCSP6-0508								



Componenti per collari serie standard

Standard clamps components

		TIPO 0					TIPO 1-6		vite T.C.E.I.		vite a testa esagonale		vite a testa esag. allungata		
		piastra inferiore multipla					piastra superiore		T.C.E.I. screws		hexagonal head screw		high hexagonal head screw		
		(LPMS...)				n°	(UPS...)		(VTEIS...)		(VTES...)		(VTEAS...)		
		F	C	N	I	collari	F	C	M	E	M	E	M	E	
		mm	mm	mm	mm	clamps	mm	mm	mm	mm	mm	mm	mm	mm	
TIPO 0		LPMS0													
		306	-	-	30	10	28	-	M6	20	M6	30	M6	20	
TIPO 1		LPMS1													
		404	20	20	40	10	37	20	M6	20	M6	30	M6	20	
TIPO 2		LPMS2													
		447	26	18	44	10	43	26	M6	25	M6	35	M6	25	
TIPO 3		LPMS3													
		525	33	19	52	10	50	33	M6	30	M6	40	M6	30	
TIPO 4		LPMS4													
		375	52	53	75	5	57	40	M6	35	M6	45	M6	35	
TIPO 5		LPMS5													
		375	52	23	75	5	69	52	M6	50	M6	60	M6	50	
TIPO 6		LPMS6													
		447	66	24	90	5	83	66	M6	60	M6	70	M6	60	

Componenti per collari serie standard

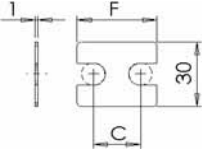
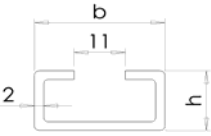
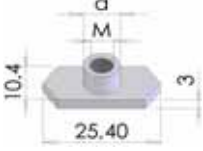
Standard clamps components

						
piastra sup. di sicurezza		binari portanti (spessore 2 mm.)		dado fissaggio binari		rondella
security upper plate		rail (thickness 2 mm)		Rail Nut		flat washer
(SUPS...)		(BINS...)		(FIXS...)		(RONS...)
F mm	C mm	b mm	h mm	M	d mm	
SUPS0						
TIPO 0 28	-					
SUPS1						
TIPO 1 34	20					
SUPS2		BINS1				
TIPO 2 41	26	28	11			
SUPS3		BINS2		FIXS1		RONS1
TIPO 3 47	33	28	14	M6	12	M6
SUPS4		BINS3				
TIPO 4 57	40					
SUPS5						
TIPO 5 67	52	28	30			
SUPS6						
TIPO 6 82	66					

CDPX Collari doppi in Polipropilene

Double Polypropylene Clamps

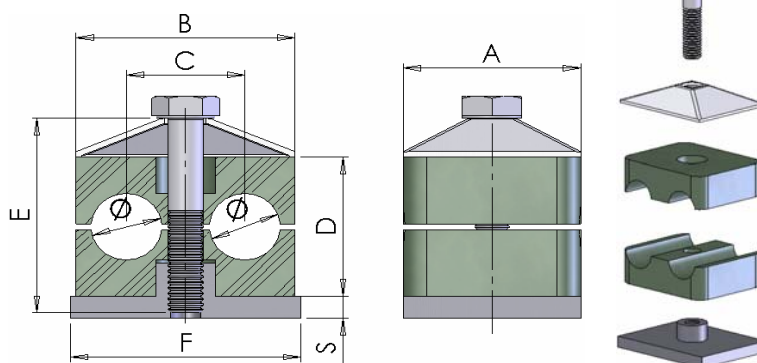

Codice Part number	Ø Tubo Ø Tube		Tipo Type	Dimensioni Dimension							
	Poll./Inch			A	B	C	D	F	S	E	
	mm	Gas		O.D.	X	mm					
CDP1-0060	6,0			1	30	37	20	25	37	3	M 6x35
CDP1-0064	6,4		1/4"								
CDP1-0080	8,0		5/16"								
CDP1-0095	9,5		3/8"								
CDP1-0100	10,0	1/8"									
CDP1-0120	12,0			2	30	53	29	26	55	5	M 6x35
CDP2-0127	12,7		1/2"								
CDP2-0135	13,5		1/4"								
CDP2-0140	14,0										
CDP2-0150	15,0		5/8"								
CDP2-0160	16,0			3	30	67	36	37	70	5	M 6x45
CDP2-0172	17,2	3/8"									
CDP2-0180	18,0										
CDP3-0190	19,0		3/4"								
CDP3-0200	20,0										
CDP3-0213	21,3	1/2"		4	30	82	45	42	85	5	M 6x50
CDP3-0220	22,0		7/8"								
CDP3-0250	25,0										
CDP3-0254	25,4		1"								
CDP4-0269	26,9	3/4"									
CDP4-0280	28,0										
CDP4-0300	30,0										
CDP5-0320	32,0		1.1/4"								
CDP5-0337	33,7	1"									
CDP5-0350	35,0			5	30	106	56	54	110	5	M 6x60
CDP5-0380	38,0		1.1/2"								
CDP5-0400	40,0										
CDP5-0420	42,0										
CDP5-0424	42,4	1.1/4"									

Componenti per collari doppi

Double clamps components

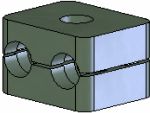
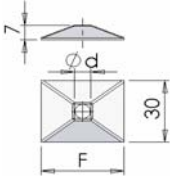
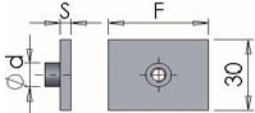
								
semi-collare in polipropilene polypropilene clamp-half		coppia collari in polipropilene polypropilene clamp body		piastra superiore upper plate		piastra inferiore lower plate		
code	price	code	price	(UPD...)		(LPD...)		
				F mm	Ød mm	F mm	Ød mm	S mm
TIPO 1	SCDP1-0060	CCDP1-0060		UPD1		LPD1		
	SCDP1-0064	CCDP1-0064						
	SCDP1-0080	CCDP1-0080						
	SCDP1-0095	CCDP1-0095		35	7	37	12	3
	SCDP1-0100	CCDP1-0100						
	SCDP1-0120	CCDP1-0120						
TIPO 2	SCDP2-0127	CCDP2-0127		UPD2		LPD2		
	SCDP2-0135	CCDP2-0135						
	SCDP2-0140	CCDP2-0140						
	SCDP2-0150	CCDP2-0150		52	9	55	14	5
	SCDP2-0160	CCDP2-0160						
	SCDP2-0172	CCDP2-0172						
	SCDP2-0180	CCDP2-0180						
TIPO 3	SCDP3-0190	CCDP3-0190		UPD3		LPD3		
	SCDP3-0200	CCDP3-0200						
	SCDP3-0213	CCDP3-0213						
	SCDP3-0220	CCDP3-0220		66	9	70	14	5
	SCDP3-0250	CCDP3-0250						
TIPO 4	SCDP4-0269	CCDP4-0269		UPD4		LPD4		
	SCDP4-0280	CCDP4-0280						
	SCDP4-0300	CCDP4-0300		81	9	85	14	5
TIPO 5	SCDP5-0320	CCDP5-0320		UPD5		LPD5		
	SCDP5-0337	CCDP5-0337						
	SCDP5-0350	CCDP5-0350						
	SCDP5-0380	CCDP5-0380		105	9	110	14	5
	SCDP5-0400	CCDP5-0400						
	SCDP5-0420	CCDP5-0420						
	SCDP5-0424	CCDP5-0424						

Componenti per collari doppi

Double clamps components

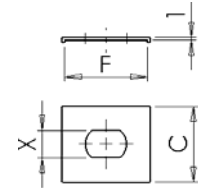
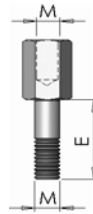
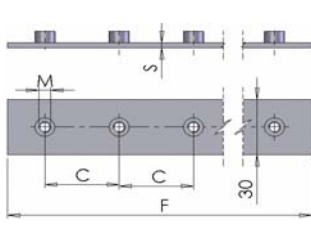

	piastra inferiore multipla multiple lower plate					vite a testa esagonale hexagonal head screw		vite a testa esag. allungata high hexagonal head screw		piastra sup. di sicurezza security upper plate		
	(LPMD...)				n° collari clamps	(VTED...)		(VTEAD...)		(SUPD...)		
	F mm	C mm	S mm	M		M	E mm	M	E mm	F mm	C mm	X mm
TIPO 1	LPMD1					VTED1		VTEAD1		SUPD1		
	200	40	3	M6	5	M6	35	M6	20	30	30	11
TIPO 2	LPMD2					VTED2		VTEAD2		SUPD2		
	290	58	5	M8	5	M8	35	M8	20			
TIPO 3	LPMD3					VTED3		VTEAD3				
	360	72	5	M8	5	M8	45	M8	29			
TIPO 4	LPMD4					VTED4		VTEAD4				
	450	90	5	M8	5	M8	50	M8	34			
TIPO 5	LPMD5					VTED5		VTEAD5				
	560	112	5	M8	5	M8	60	M8	47			

Componenti per collari doppi

Double clamps components

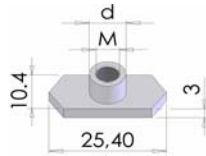
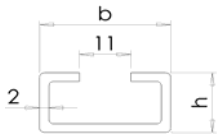

binari portanti (spessore 2 mm.) rail (thickness 2 mm)			dado fissaggio binari Rail Nut			
(BIND...)			(FIXD...)			
b mm	h mm		M	d mm		
TIPO 1			FIXD1			
			M6	12		
BIND1			FIXD2			
TIPO 2	28	11				
BIND2						
TIPO 3	28	14			M8	14
BIND3						
TIPO 4	28	30				
TIPO 5						

CHPX Collari serie pesante in Polipropilene

Heavy duty Polypropilene Clamps

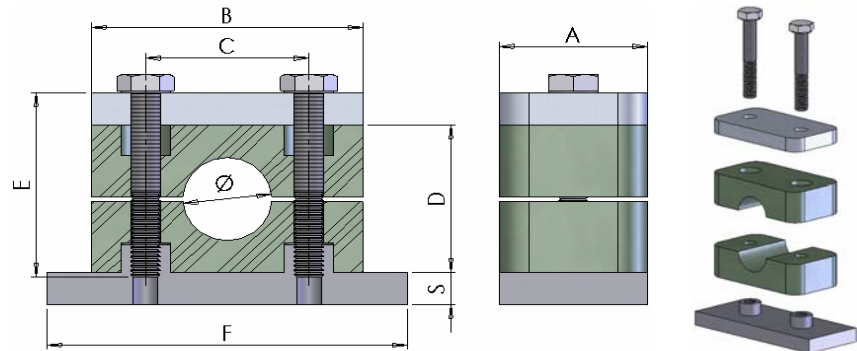

Codice Part number	Ø Tubo Ø Tube		Tipo Type	Dimensioni Dimension								
	Poll./Inch			A	B	C	D	F	S	E		
	mm	Gas		O.D.	X	mm						
CHP1-0060	6,0											
CHP1-0064	6,4		1/4"									
CHP1-0080	8,0		5/16"									
CHP1-0095	9,5		3/8"									
CHP1-0100	10,0	1/8"										
CHP1-0120	12,0											
CHP1-0127	12,7		1/2"	1	30	55	33	32	73	8	M 6x35	
CHP1-0135	13,5	1/4"										
CHP1-0140	14,0											
CHP1-0150	15,0											
CHP1-0160	16,0		5/8"									
CHP1-0172	17,2	3/8"										
CHP1-0180	18,0											
CHP2-0190	19,0		3/4"									
CHP2-0200	20,0											
CHP2-0213	21,3	1/2"										
CHP2-0220	22,0		7/8"									
CHP2-0250	25,0			2	30	70	45	48	85	8	M 6x35	
CHP2-0254	25,4		1"									
CHP2-0269	26,9	3/4"										
CHP2-0280	28,0											
CHP2-0300	30,0											
CHP3-0300	30,0											
CHP3-0320	32,0		1.1/4"									
CHP3-0337	33,7	1"										
CHP3-0350	35,0											
CHP3-0380	38,0		1.1/2"	3	30	85	60	60	10	8	M 6x45	
CHP3-0400	40,0											
CHP3-0420	42,0											
CHP3-0424	42,4	1.1/4"										
CHP4-0380	38,0		1.1/2"									
CHP4-0420	42,0											
CHP4-0424	42,4	1.1/4"		4	45	120	90	90	140	10	M 12x100	
CHP4-0445	44,5		1.3/4"									
CHP4-0483	48,3	1.1/2"										

CHPX Collari serie pesante in Polipropilene

Heavy duty Polypropilene Clamps

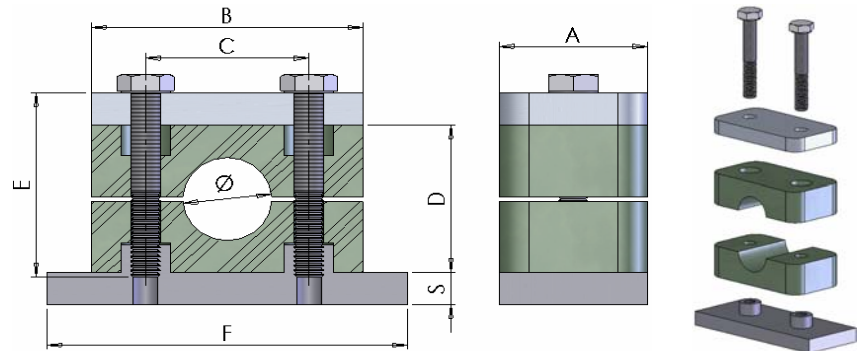

Codice Part number	Ø Tubo Ø Tube		Tipo Type	Dimensioni Dimension								
	Poll./Inch			A	B	C	D	F	S	E		
	mm	Gas		O.D.	X	mm						
CHP4-0500	50,0											
CHP4-0508	50,8		2"									
CHP4-0550	55,0											
CHP4-0570	57,0		2.1/4"	4	45	120	90	90	140	10	M 12x100	
CHP4-0603	60,3	2"										
CHP4-0635	63,5		2.1/2"									
CHP4-0650	65,0											
CHP4-0700	70,0		2.3/4"									
CHP5-0650	65,0											
CHP5-0700	70,0											
CHP5-0750	75,0											
CHP5-0761	76,1	2.1/2"	3"	5	60	152	122	120	180	10	M 16x130	
CHP5-0800	80,0											
CHP5-0825	82,5		3.1/4"									
CHP5-0889	88,9	3"	3.1/2"									
CHP6-0899	89,9	3"	3.1/2"									
CHP6-1000	100,0											
CHP6-1016	101,6	3.1/2"	4"									
CHP6-1080	108,0		4.1/4"	6	80	205	168	170	225	15	M 20x190	
CHP6-1143	114,3	4"	4.1/2"									
CHP6-1270	127,0	4.1/2"	5"									
CHP6-1330	133,0		5.1/2"									
CHP7-1330	133,0		5.1/4"									
CHP7-1397	139,7	5"	5.1/2"									
CHP7-1524	152,4	5.1/2"	6"	7	90	250	205	200	270	15	M 24x220	
CHP7-1650	165,0		6.1/2"									
CHP7-1683	168,3	6"										
CHP8-1683	168,3	6"										
CHP8-1778	177,8		7"									
CHP8-1937	193,7		7.5/8"	8	120	320	265	270	340	25	M 30x300	
CHP8-2160	216,0		8.1/2"									
CHP8-2191	219,1	8"										

Componenti per collari serie pesante

Heavy clamps components

semi-collare in polipropilene		coppia collari in polipropilene		piastra inferiore				piastra superiore					
polypropilene clamp-half		polypropilene clamp body		lower plate				upper plate					
code	price	code	price	(LPH...)				(UPH...)					
				A mm	F mm	C mm	S mm	A mm	F mm	C mm	S mm		
				LPH1				UPH1					
SCHP1-0060		CCHP1-0060											
SCHP1-0064		CCHP1-0064											
SCHP1-0080		CCHP1-0080											
SCHP1-0095		CCHP1-0095											
SCHP1-0100		CCHP1-0100											
SCHP1-0120		CCHP1-0120											
SCHP1-0127		CCHP1-0127		30	75	33	8	30	55	33	8		
SCHP1-0135		CCHP1-0135											
SCHP1-0140		CCHP1-0140											
SCHP1-0150		CCHP1-0150											
SCHP1-0160		CCHP1-0160											
SCHP1-0172		CCHP1-0172											
SCHP1-0180		CCHP1-0180											
				LPH2				UPH2					
SCHP2-0190		CCHP2-0190											
SCHP2-0200		CCHP2-0200											
SCHP2-0213		CCHP2-0213											
SCHP2-0220		CCHP2-0220											
SCHP2-0250		CCHP2-0250											
SCHP2-0254		CCHP2-0254		30	87	45	8	30	70	45	8		
SCHP2-0269		CCHP2-0269											
SCHP2-0280		CCHP2-0280											
SCHP2-0300		CCHP2-0300											
SCHP2-0300		CCHP2-0300											
				LPH3				UPH3					
SCHP3-0300		CCHP3-0300											
SCHP3-0320		CCHP3-0320											
SCHP3-0337		CCHP3-0337											
SCHP3-0350		CCHP3-0350											
SCHP3-0380		CCHP3-0380		30	102	60	8	30	85	60	8		
SCHP3-0400		CCHP3-0400											
SCHP3-0420		CCHP3-0420											
SCHP3-0424		CCHP3-0424											
				LPH4				UPH4					
SCHP4-0380		CCHP4-0380											
SCHP4-0420		CCHP4-0420											
SCHP4-0424		CCHP4-0424											
SCHP4-0445		CCHP4-0445		45	140	90	10	45	120	90	10		
SCHP4-0483		CCHP4-0483											

Componenti per collari serie pesante

Heavy clamps components

semi-collare in polipropilene		coppia collari in polipropilene		piastra inferiore				piastra superiore			
polypropilene clamp-half		polypropilene clamp body		lower plate				upper plate			
code	price	code	price	(LPH...)				(UPH...)			
				A	F	C	S	A	F	C	S
				mm	mm	mm	mm	mm	mm	mm	mm
				LPH4				UPH4			
TIPO 4	SCHP4-0500	CCHP4-0500									
	SCHP4-0508	CCHP4-0508									
	SCHP4-0550	CCHP4-0550									
	SCHP4-0570	CCHP4-0570									
	SCHP4-0603	CCHP4-0603		45	140	90	10	45	120	90	10
	SCHP4-0635	CCHP4-0635									
	SCHP4-0650	CCHP4-0650									
	SCHP4-0700	CCHP4-0700									
				LPH5				UPH5			
TIPO 5	SCHP5-0650	CCHP5-0650									
	SCHP5-0700	CCHP5-0700									
	SCHP5-0750	CCHP5-0750									
	SCHP5-0761	CCHP5-0761		60	180	122	10	60	152	122	10
	SCHP5-0800	CCHP5-0800									
	SCHP5-0825	CCHP5-0825									
	SCHP5-0889	CCHP5-0889									
				LPH6				UPH6			
TIPO 6	SCHP6-0899	CCHP6-0899									
	SCHP6-1000	CCHP6-1000									
	SCHP6-1016	CCHP6-1016									
	SCHP6-1080	CCHP6-1080		80	225	168	15	80	205	168	15
	SCHP6-1143	CCHP6-1143									
	SCHP6-1270	CCHP6-1270									
				LPH7				UPH7			
TIPO 7	SCHP7-1330	CCHP7-1330									
	SCHP7-1397	CCHP7-1397									
	SCHP7-1524	CCHP7-1524									
	SCHP7-1650	CCHP7-1650		90	270	205	15	90	250	205	15
	SCHP7-1683	CCHP7-1683									
				LPH8				UPH8			
TIPO 8	SCHP8-1683	CCHP8-1683									
	SCHP8-1778	CCHP8-1778									
	SCHP8-1937	CCHP8-1937									
	SCHP8-2160	CCHP8-2160		120	340	265	25	120	320	265	25
	SCHP8-2191	CCHP8-2191									

Componenti per collari serie pesante

Heavy clamps components

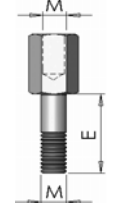
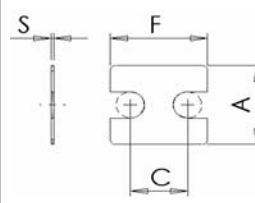
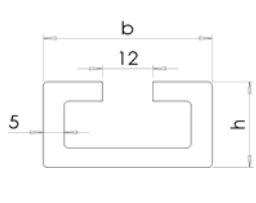
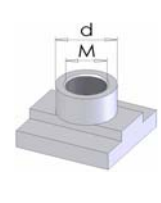
					
	vite a testa esagonale	vite a testa esag. allungata	piastra superiore di sicurezza	binari portanti (spessore 5 mm.)	dado fissaggio binari
	hexagonal head screw	high hexagonal head screw	security upper plate	rail (thickness 5 mm)	rail nut
	(VTEH...)	(VTEAH...)	(SUPH...)	(BINH...)	(FIXH...)
	M E mm	M E mm	A F C S mm mm mm mm	b h mm mm	M d mm
TIPO 1	VTEH1	VTEAH1	SUPH1		
	M10 45	M10 26	30 55 33 8		
TIPO 2	VTEH2	VTEAH2	SUPH2	BINH1	FIXH1
	M10 60	M10 41	30 70 45 8	40 22	M10 18
TIPO 3	VTEH3	VTEAH3	SUPH3		
	M10 70	M10 52	30 85 60 8		

Componenti per collari serie pesante

Heavy clamps components

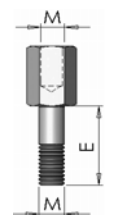
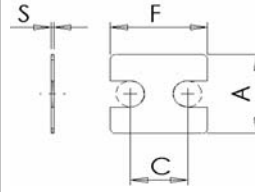
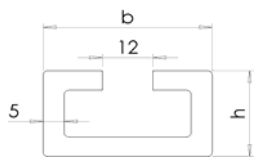
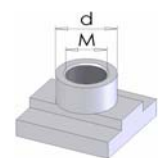
					
	vite a testa esagonale	vite a testa esag. allungata	piastra superiore di sicurezza	binari portanti (spessore 5 mm.)	dado fissaggio binari
	hexagonal head screw	high hexagonal head screw	security upper plate	rail (thickness 5 mm)	rail nut
	(VTEH...)	(VTEAH...)	(SUPH...)	(BINH...)	(FIXH...)
	M E mm	M E mm	A F C S mm mm mm mm	b h mm mm	M d mm
	VTEH4	VTEAH4	SUPH4		
TIPO 4	M12 100	M12 83	45 120 90 10	BINH1	FIXH2
	VTEH5	VTEAH5	SUPH5	40 22	M12 20
TIPO 5	M16 130	M16 110	60 152 122 10		
	VTEH6				
TIPO 6	M20 190	- -	- - - -	- -	- -
	VTEH7				
TIPO 7	M24 220	- -	- - - -	- -	- -
	VTEH8				
TIPO 8	M30 300	- -	- - - -	- -	- -